

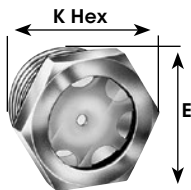

Fused Window Sights

- **Pressure:** 125 PSI maximum
- **Temperature:** 250°F maximum
- **Body:** Steel, plated
- **Reflector:** Stainless steel
- **Sight:** Glass

Plated body is made of sturdy hexagon steel and features various NPT sizes which can be mounted in any ordinary pipe thread. Stainless steel reflector enhances visibility of liquid level. These special reflectors will not tarnish, corrode or discolour under most adverse conditions.



NPT	E"	K"	w/o Reflector Model No.	Price /Each	w/Reflector Model No.	Price /Each
1/4	5/8	5/8	AB041	-	-	-
3/8	3/4	3/4	AB049	-	AB042	-
1/2	25/32	15/16	AB050	-	AB043	-
3/4	11/16	11/16	AB051	-	AB044	-
1	11/16	13/8	AB052	-	AB045	-
1 1/4	17/32	13/4	AB053	-	AB046	-
1 1/2	17/32	2	AB054	-	AB047	-
2	19/32	2 1/2	AB055	-	AB048	-

Vent Plugs

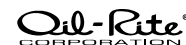

Vent plugs with filters can be used to relieve pressure or vacuum. These vent plugs assure pressure equalization and minimize undesirable problems, such as excessive pressure. The vent plugs allow air to freely communicate through a 40 micron filter. Steel plated body. Maximum temperature: 225°F.

Vent plugs with deflectors can also serve as filler plugs. They are equipped with a splash deflector which prevents the liquid from spilling into the vent hole and outside. To allow air to communicate freely with the outside, no screens or filters are used which might make the units inoperative.

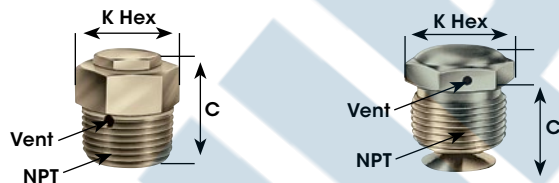

Model No.	NPT Size	C"	K"	Price /Each
VENT PLUGS WITH FILTERS				
AB062	1/8 Male	1	11/16	-
AB063	1/4 Male	1	11/16	-
AB064	3/8 Male	1 1/16	3/4	-
AB065	1/2 Male	13/16	15/16	-
AB066	3/4 Male	1 1/4	1 1/16	-

Model No.	NPT Size	C"	K"	Price /Each
VENT PLUGS WITH DEFLECTORS				
AB056	1/8 Male	15/16	7/16	-
AB057	1/4 Male	1	9/16	-
AB058	3/8 Male	1 1/8	11/16	-
AB059	1/2 Male	13/16	15/16	-
AB060	3/4 Male	1 1/4	1 1/16	-
AB061	1 Male	13/8	13/8	-

Aluminum & Round Nylon Liquid Level Gauges

- **Pressure:** 175 PSI maximum (Alum.)
- **Temperature:** 225°F maximum (Alum.)
- **Pressure:** 125 PSI maximum @ 72°F (Round)
- **Temperature:** 205°F maximum (Round)
- **Body or end blocks:** Aluminum alloy
- **Sight:** Glass (Aluminum) - Round nylon (Trogamid)
- **Seals:** Buna-N
- **Mounting kits:** Studs - aluminum, plated steel

These gauges are used to view oil levels in hydraulic reservoirs, gearboxes, bearing housings, crank cases, transformers and machinery oil reservoirs. The universal design accommodates both front and back mounting. Models with a thermometer will also show the temperature of the liquid. Aluminum components resist rust and corrosion.



Alum. Model No.	Price /Each	Alum. Model No.	Price /Each	Round Model No.	Price /Each	Round Model No.	Price /Each	A"
AD856	-	AD862*	-	AD868	-	AD874*	-	5
AD857	-	AD863*	-	AD869	-	AD875*	-	6
AD858	-	AD864*	-	AD870	-	AD876*	-	7
AD859	-	AD865*	-	AD871	-	AD877*	-	9
AD860	-	AD866*	-	AD872	-	AD878*	-	10
AD861	-	AD867*	-	AD873	-	AD879*	-	12

Centreline distance 3"-36" between centre of studs are also available.
* With thermometer

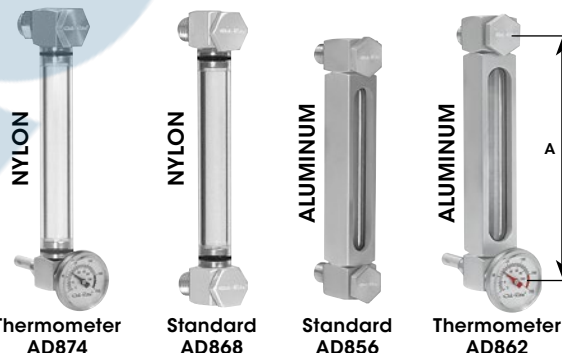

Brass Liquid Level Gauges

- **Pressure:** Atmospheric pressure, cap is vented
- **Temperature:** 225°F max
- **Body:** Brass
- **Sight:** Glass
- **Seal:** Buna-N
- **Washer:** Teflon
- **Cap:** Brass
- **Union Coupling:** Steel, plated

Brass gauges are used to indicate level of lubricating liquid supply at bearings, gear boxes, crank cases, transformers, switches etc. These gages are easily installed in any location having enough clearance for a one-piece oil gage.



STRAIGHT

Model No.	Glass Dia."	NPT Size	A"	Price /Each
AD844	1/2	1/4	2 7/16	-
AD845	1/2	1/4	2 15/16	-
AD846	1/2	1/8	3 3/8	-
AD847	1/2	1/4	3 7/16	-
AB077	1/2	3/8	4	-
AD682	1/2	1/4	4 7/16	-
AD685	1/2	1/4	4 15/16	-
AD686	1/2	3/8	5	-
AD688	1/2	1/4	5 7/16	-
AD691	1/2	1/4	5 15/16	-
AD692	1/2	3/8	6	-
AB085	5/8	1/2	7 1/4	-
AB086	5/8	1/2	9 1/4	-
AB082	5/8	1/2	11 1/4	-
AD721	5/8	3/8	14 1/8	-
AB083	5/8	1/2	14 1/4	-

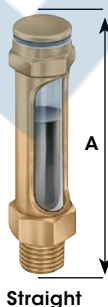

Straight

SHORT ELBOW

Model No.	Glass Dia."	NPT Size	A"	Price /Each
AD841	1/2	1/8	1 15/16	-
AD842	1/2	1/4	1 15/16	-
AD843	1/2	3/8	1 15/16	-
AD587	1/2	1/4	3 7/16	-
AD589	1/2	1/4	3 15/16	-
AD591	1/2	1/8	4 7/16	-
AD592	1/2	1/4	4 7/16	-
AD593	1/2	3/8	4 7/16	-
AD596	1/2	3/8	4 15/16	-
AB074	1/2	1/4	5 7/16	-
AD628	5/8	1/4	5 1/2	-
AD630	5/8	1/2	5 1/2	-

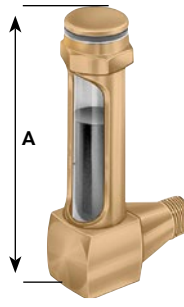

Short

UNION COUPLING

Model No.	Glass Dia."	NPT Size	A"	Price /Each
AD852	1/2	1/4	2 7/16	-
AD853	1/2	1/4	2 15/16	-
AD659	1/2	1/4	3 7/16	-
AB091	1/2	3/8	3 7/16	-
AD662	1/2	3/8	3 15/16	-
AD665	1/2	3/8	4 7/16	-
AB092	1/2	1/4	5 7/16	-
AD672	1/2	1/4	6 7/16	-
AB234	5/8	1/2	5 7/16	-
AB235	5/8	1/2	8 11/16	-

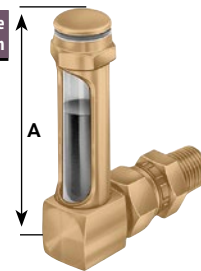

Union